

INGCO

Skús
KiNEKUS
EXKLUZÍVNY DODÁVATEĽ

NÁRADIE DO TVOJICH RÚK

NOVINKY 2022

V katalógu nájdete
aj novinky pre rok 2022



VÝBORNÝ POMER CENA / KVALITA

INGCO

NÁRADIE DO TVOJICH RÚK

KiNEKUS

EXKLUZÍVNY DODÁVATEĽ

Náš príbeh

Rozhodli sme sa pre vás **EXKLUZÍVNE NA SLOVENSKO DOVIEZŤ** značku **INGCO** [čítajte INKO].

Chceme dať ľuďom to, čo si najviac žiadajú,
VÝBORNÝ POMER CENY A KVALITY.

INGCO patrí podľa niektorých blogov medzi
TOP 14 NAJLEPŠÍCH VÝROBCOV NÁRADIA.*

Sme radi, že vám môžeme predstaviť **UCELENÚ PONUKU KVALITNÉHO NÁRADIA,** ktorú budeme ďalej rozširovať.

Na väčšine produktov je použitá chrómvanádiová oceľ (CrV).
JE PEVNEJŠIA A TRVÁCNEJŠIA ako bežné druhy ocele.

Navyše, v ponuke sú aj produkty s označením **INDUSTRIAL,**
KTORÉ SÚ VYVINUTÉ PRE ZVÝŠENÚ ZÁŤAŽ.

VYSKÚŠAJ A UŽ HO NEPUSTÍŠ Z RUKY

Obsah



4 - Kliešte



9 - Skrutkovače



10 - Sady náradia a skrutkovačov



14 - Kľúče



15 - Lámacie nože



16 - Práca v dielni



18 - Pomôcky na stavbu



22 - Maľovanie



23 - Starostlivosť o záhradu



25 - Práca s drevom

NOVINKY 2022



str. 9



str. 9



str. 13



str. 19



str. 11



str. 11



str. 17



str. 11



str. 18-19



str. 21



str. 7



str. 7



str. 7



str. 21



str. 21



str. 21



str. 21



str. 16



str. 15



str. 6



str. 6



str. 20



str. 17



str. 22



str. 22



str. 22



str. 22



str. 22



str. 20



str. 5



str. 4



str. 27



str. 25



str. 26



str. 25



str. 17



str. 17

KLIESTE

PRE KAŽDÚ PRÍLEŽITOSŤ

Kombinované kliešte

chrómvanádiová oceľ,
antikorózna úprava, ergonomická
dvojfarebná TPR rúkovať,
BAL: 36



6 925582 120462

1531028168 160 mm



6 925582 120479

1531028188 180 mm



6 925582 120486

1531028208 200 mm

INDUSTRIAL
VYVINUTÉ PRE VÄCSIU ZÁTAŽ



ANTIKORÓZNA ÚPRAVA ČELUSTÍ

CHROM-VANÁDIOVÁ OCEĽ

OBOJRUČNÉ (PRE LAVÁKOV AJ PRAVÁKOV)

ERGONOMICKÁ RUKOVÄŤ S PROTIŠMYKOVOU ÚPRAVOU,
VYROBENÁ Z KVALITNÉHO MATERIÁLU TPR



Rádiové kliešte

chrómvanádiová oceľ, antikorózna
úprava, ergonomická dvojfarebná
TPR rúkovať
BAL: 36



6 925582 120516

1531328168 160 mm



6 925582 151077

1531328208 200 mm

INDUSTRIAL
VYVINUTÉ PRE VÄCSIU ZÁTAŽ



Štipacie kliešte

čelné, chrómvanádiová oceľ,
antikorózna úprava, dĺžka 160 mm,
ergonomická dvojfarebná TPR rúkovať,
celková hmotnosť 190 g
BAL: 36



6 928073 676110

INDUSTRIAL
VYVINUTÉ PRE VÄCSIU ZÁTAŽ



Rabicové kliešte

chrómvanádiová oceľ,
antikorózna úprava,
plastová rúkovať
BAL: 36



6 928073 675472



6 928073 675489

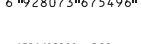

1531602200 200 mm

1531602230 228 mm

1531602250 250 mm



Štipacie kliešte

kliešte štipacie čelné
z chrómvanádiovej ocele,
antikorózna úprava,
dĺžka 200 mm, ergonomická
dvojfarebná TPR rúkovať
BAL: 6



6 928073 675519



NOVINKA

Štipacie kliešte

bočné, chrómvanádiová oceľ,
antikorózna úprava, ergonomická
dvojfarebná TPR rúkovať
BAL: 36



1531128168 160 mm
1531128188 180 mm

INDUSTRIAL
VYVINUTÉ PRE VÄCSIU ZÁTÄŽ



Štipacie kliešte

HEAVY DUTY, bočné, chrómvanádiová oceľ,
antikorózna úprava, dĺžka 180 mm, ergonomická
dvojfarebná TPR rúkovať, hmotnosť 300 g
BAL: 36
1531228188



INDUSTRIAL
VYVINUTÉ PRE VÄCSIU ZÁTÄŽ



Kombinované kliešte MINI

mini kombinované kliešte, leštená
úprava, celková dĺžka len 115 mm,
ergonomická dvojfarebná TPR rúkovať
BAL: 12
1531908115



NOVINKA

Kliešte MINI

mini dlhé ploché kliešte, leštená úprava,
celková dĺžka len 115 mm, ergonomická
dvojfarebná TPR rúkovať
BAL: 12
1531958115



NOVINKA

Radiové kliešte MINI

mini, rovné, leštená úprava, celková
dĺžka len 115 mm, ergonomická
dvojfarebná TPR rúkovať
BAL: 12
1531938115



NOVINKA

Štipacie kliešte MINI

mini štipacie čelné kliešte, leštená
úprava, celková dĺžka len 115 mm,
ergonomická dvojfarebná TPR rúkovať
BAL: 12
1531918115



NOVINKA

Štipacie kliešte MINI

mini štipacie bočné kliešte, leštená
úprava, celková dĺžka len 115 mm,
ergonomická dvojfarebná TPR rúkovať
BAL: 12
1531928115



NOVINKA

Radiové kliešte MINI

mini, zahnuté, leštená úprava, celková
dĺžka len 115 mm, ergonomická
dvojfarebná TPR rúkovať
BAL: 12
1531948115



NOVINKA

Pákové kliešte

kalené čeluste z chrómvanádiovej ocele, ergonomicky tvarovaná dvojfarebná TPR rukoväť

RUKOVÄTE Z TPR PRE LEPŠIE UCHOPENIE

INDUSTRIAL
VYVINUTÉ PRE VACŠIU ZÁŤAŽ

6 925582 115381	1531700812	12"/300 mm	BAL: 20
6 925582 116779	1531700814	14"/350 mm	BAL: 16
6 925582 116786	1531700818	18"/450 mm	BAL: 12
6 925582 117097	1531700824	24"/610 mm	BAL: 6
6 925582 117103	1531700830	30"/760 mm	BAL: 4



ČELUSTE: CHROM-VANÁDIOVÁ OCEĽ

Rýchlopínacie kliešte

rovné čeluste, uhlíková oceľ, celková dĺžka 250 mm, ovládací šrób na nastavenie hrúbky materiálu, páka pre rýchle odistenie

BAL: 30

1531700110

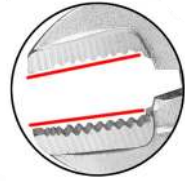

Rýchlopínacie kliešte

zahnuté čeluste, uhlíková oceľ, celková dĺžka 250 mm, ovládací šrób na nastavenie hrúbky materiálu, páka pre rýchle odistenie

BAL: 30

1531700210

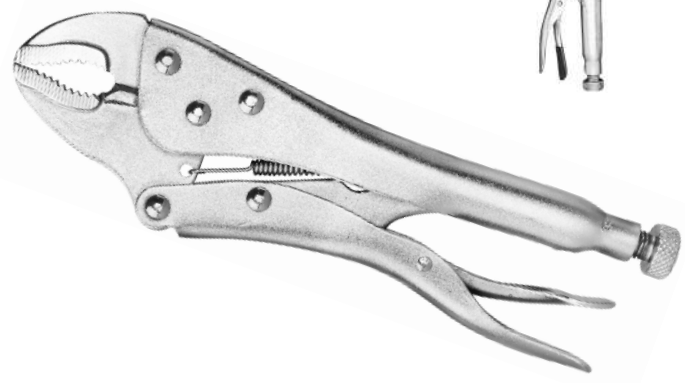

Rýchlopínacie kliešte

kovové rýchlopínacie kliešte, rovné dlhé čeluste, uhlíková oceľ, celková dĺžka 230 mm, ovládací šrób na nastavenie hrúbky materiálu, páka pre rýchle odistenie

BAL: 5

1531700209



NOVINKA



Rýchlopínacie kliešte

kovové rýchlopínacie kliešte, čeluste v tvare C, uhlíková oceľ, celková dĺžka 230 mm, ovládací šrób na nastavenie hrúbky materiálu, páka pre rýchle odistenie

BAL: 5

1531700211



NOVINKA



Nitovacie kliešte ALU PROFI

vyrobné z hliníkovej zliatiny, na ručné nitovanie nitov s priermi 2,4/3,2/4,0/4,8 mm dĺžka klieští 265 mm, rúčky z TPR pre lepšie uchopenie, priložený kľúč na výmenu nitovacích hlavíc

BAL: 24



INDUSTRIAL
VYVINUTÉ PRE VÄČŠIU ZÁTAŽ

Nitovacie kliešte

oceľové, na ručné nitovanie nitov s priermi 2,4/3,2/4,0/4,8 mm, dĺžka 255 mm, priložený kľúč na výmenu nitovacích hlavíc

BAL: 24

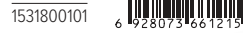

Nitovacie kliešte

oceľové, na ručné nitovanie nitov s priermi 2,4/3,2/4,0/4,8 mm, dĺžka 265 mm, priložený kľúč na výmenu nitovacích hlavíc

BAL: 24



Odizolovacie kliešte

odizolovacie kliešte s funkciou stlačenia kábla, dĺžka 215 mm, ergonomická dvojfarebná rukoväť, vhodné na 7 rôznych hrúbok odizolovania kábla, strihanie rôznych priemerov kábla a medených skrutiiek

BAL: 12

1531500851



NOVINKA



Segerové kliešte

kliešte na segerkové krúžky, z kARBÓNEJ OCELE, dĺžka 180 mm, pohodlná rukoväť, priemer konca hlavy 1,8 mm

BAL: 6



1531411802 vnútorné



1531411801 vonkajšie

NOVINKA



Kliešte na PVC trúbky

celokovové, na trúbky priemeru 3-42 mm, prevodový mechanizmus, funkcia automatického otvorenia, celková dĺžka 193 mm

BAL: 48

1531800543



Segerové kliešte

kliešte na segerkové krúžky zahnuté, z kARBÓNEJ OCELE, dĺžka 180 mm, pohodlná rukoväť, priemer konca hlavy 1,8 mm

BAL: 6



1531411752 vnútorné



1531411751 vonkajšie

NOVINKA



KLIESTE A HASÁKY

Kliešte SIKO nastaviteľné

chrómvanádiová oceľ, 40 mm, antikorózna úprava, dĺžka 250 mm, ergonomická dvojfarebná TPR rúkavť

BAL: 36

1531728258



6 925582 1130720



INDUSTRIAL
VYVINUTÉ PRE VÄČŠIU ZÁŤAŽ

Hasák s maticou

celokovový, pogumovaná rúkavť, drážkované čeluste so zubami, rýchle a jednoduché nastavenie rozteče pomocou matice, vrchná čelust z uhlíkovej ocele



6 925582 115680



6 925582 114232



6 925582 115024



6 925582 115031



6 925582 116533

1532000810 34/250 mm BAL: 6

1532000812 42/300 mm BAL: 3

1532000814 50/350 mm BAL: 12

1532000818 60/450 mm BAL: 10

1532000824 76/610 mm BAL: 4

INDUSTRIAL
VYVINUTÉ PRE VÄČŠIU ZÁŤAŽ



Hasák so spodnou maticou

HEAVY DUTY, uhlíková oceľ, pogumovaná rúkavť, drážkované čeluste 90° so zubami, rýchle a jednoduché nastavenie rozteče

BAL: 24

1532004011



6 925582 115925



6 925582 115949

1532004011 0-40 mm BAL: 24

1532004151 0-55 mm BAL: 16



Kliešte SIKO nastaviteľné

chrómvanádiová oceľ, 50 mm, antikorózna úprava, dĺžka 250 mm, ergonomická dvojfarebná TPR rúkavť

BAL: 36

1531728251



6 925582 132281



Nastaviteľný kľúč

chrómvanádiová oceľ, nastaviteľný rozsah, celková dĺžka 250 mm, ergonomická rúkavť



6 925582 103731



6 925582 103700



6 925582 103717

1536131088 0-30 mm dĺžka 200 mm BAL: 24

1536131108 0-35 mm dĺžka 250 mm BAL: 24

1536131128 0-41 mm dĺžka 300 mm BAL: 16



Hasák s maticou Heavy Duty

celokovový, drážkované čeluste 45° so zubami, rýchle a jednoduché nastavenie rozteče pomocou matice, vyrobené z kvalitnej uhlíkovej ocele

BAL: 24

1532004013



6 925582 136951



6 925582 136708

1532004013 0-40 mm BAL: 24

1532004153 0-55 mm BAL: 16



SKRUTKOVAČE

Krížový skrutkovač

z vysokokvalitnej ocele S2, má magnetický hrot, ergonomická rukoväť s protisklzovými vlastnosťami
BAL: 12



- 1533320075 3x75 mm, PH0
- 1533321100 5x100 mm, PH1
- 1533322125 6x125 mm / PH2
- 1533322150 6x150 mm, PH2
- 1533323200 8x200 mm, PH3

INDUSTRIAL
VYVINUTÉ PRE VÄČŠIU ZÁŤAŽ

NOVINKA



Skrutkovač FLEXI

sada skrutkovač+bity, flexibilný krk skrutkovača pre neprístupné aplikácie, 12 kusov
BAL: 48



1533401208

Skrutkovač s obojstranným hrotom

dvojitý skrutkovač 2v1, z kvalitnej chrómovanádiovej ocele, ergonomická rukoväť s protisklzovými vlastnosťami, obsahuje plochý SL6 a krížový PH2 skrutkovač
BAL: 12

1533400201



- 1533400203 5x135 mm
- 1533400201 6,35x160 mm

NOVINKA



Plochý skrutkovač

z vysokokvalitnej ocele S2, má magnetický hrot, ergonomická rukoväť s protisklzovými vlastnosťami
BAL: 12

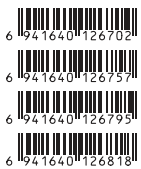

- 1533314100 4x100 mm
- 1533315100 5x100 mm
- 1533316150 6,5x150 mm
- 1533318200 8x200 mm



Sada úderových skrutkovačov

sada 6 ks, oceľ pevnosti 40Cr, obsahuje 1 ks SL5.5*75 mm, 1 ks SL6.5*100 mm, 1 ks SL8.0*150 mm, 1 ks PH1*75 mm, 1 ks PH2*100 mm, 1 ks PH3*150 mm + 1 ks plastový držiak
BAL: 5

1533418601

NOVINKA



Úderové skrutkovače

vysokopevnostná oceľ, kalený magnetický hrot, tvar hriadele šesťhran, ergonomická protisklzová rukoväť, 1x plochý 6,5x125 mm, 1x krížový PH2 6x125 mm
BAL: 30

1533280208



INDUSTRIAL
VYVINUTÉ PRE VÄČŠIU ZÁŤAŽ



INDUSTRIAL
VYVINUTÉ PRE VÄČŠIU ZÁŤAŽ

NOVINKA

SADY

NÁRADIA A SKRUTKOVAČOV



Gola sada 1/4"

45-dielna sada v plastovom kufríku, račňa, predĺženia, orechy gola 4-14 mm, 20 ks nadstavcov na skrutkovač + adaptér

BAL: 6

1534014451



6 928073 673287

sada
45 ks



Sada náradia v kufríku

1/2" gola orechy 10-32 mm, vrátane predĺžených nástavcov a adaptérov, račňa 1/4", 1/4" gola orechy 4-13 mm, 14x nadstavce na 1/4" račňu, 1x kliešte kombinované, 1x kliešte štipacie bočné, 1x skrutkovač plochý, 14x nadstavce na skrutkovač, 9x imbusový kľúč, 1x kladivo 300 g

BAL: 4

1534020771



6 923582 114513

sada
77 ks



Sada náradia v kufríku

obsahuje 60 ks náradia + 60 ks skrutiek rôznych rozmerov, v originálnom kufríku INGCO, obsahuje: 1x kladivo, 1x kombinované kliešte 180 mm, 1x rovné kliešte 150 mm, 1x skrutkovač plochý 5,5x100, 1x skrutkovač krížový PH1x100, 1x testovacie pero 100-500 VAC, 1x nastaviteľný kľúč 200mm, 1x pásmo 3 m, 1x mini píla na železo, 9x imbusový kľúč, 20x bity, 1x zalamovací nôž, 1x jemný skrutkovač, 10x bity do jemného skrutkovača, 1x pilník polokrúhly 3x140 mm, 1x nožnice 200 mm, 7x imbusové orechy do skrutkovača, materiál CR-V, 1x magnetický držiak bitov

BAL: 4

1534021201



NOVINKA



sada
60 ks



Sada náradia v kufríku

29 dielna sada náradia INGCO, obsahuje: 1x 180 mm kombinované kliešte, 1x 155 mm štipacie kliešte, 1x 200 mm nastaviteľný kľúč, 1x testovacie pero 100-500 VAC, 1x 3 m oceleové meracie pásmo, 1x zalamovací výsuvný nôž, 1x 140 mm nožnice, 1x magnetické rameno, 1x vodováha - príviesok, 20 ks 1/4" bitov do skrutkovača: SL3, SL4, SL5, SL6, H0, PH1, PH2, PH3, PZ0, PZ1, PZ2, PZ3, T10, T15, T20, T30, H3, H4, H5, H6 25mm, balené v plastovom boxe

BAL: 5

1534010291



NOVINKA



sada
29 ks



Račňový skrutkovač + bity

55-dielna sada, skrutkovač veľký + skrutkovač malý, 21 bitov veľkých, 20 bitov malých, 9x gola orech, 1x adaptér gola, 2x nadstavce

BAL: 24

1533400558



sada
55 ks



Sada skrutkovač račňa + bity

26 ks, obsahuje: 1 ks račňovej rúčky INGCO, 18 ks bitov: PH0, PH1, PH2, PH3, PZ1, PZ2, PZ3, SL3, SL4, SL5, SL6, SL7, T10, T15, T20, T25, T27, T30, 6 ks gola 5 mm, 6 mm, 7 mm, 8 mm, 9 mm, 10 mm, materiál CR-V, 1 ks obal

BAL: 6

1533400268



sada
26 ks

NOVINKA



26 dielov



Sada skrutkovačov

8-dielna, chrómvanádiová oceľ, kalené magnetické hroty, ergonomická protisklzová rukoväť - INGCO dizajn, SL3.0*3*75, SL5.5*5*100, SL6.5*6*150, SL6.5*6*38, PH0*3*75, PH1*5*75, PH2*6*125, PH2*6*38
BAL: 20

1533400828



sada
8 ks

INDUSTRIAL
VYVINUTÉ PRE VÄČŠIU ZÁŤAŽ



Sada skrutkovačov

6-dielna, chrómvanádiová oceľ, kalené magnetické hroty, ergonomická protisklzová rukoväť - INGCO dizajn, SL5.5*5*75, SL5.5*5*100, SL6.5*6*150, PH1*5*75, PH1*5*100, PH2*6*150
BAL: 20

1533400628



sada
6 ks

INDUSTRIAL
VYVINUTÉ PRE VÄČŠIU ZÁŤAŽ



Sada skrutkovačov

18-dielna sada, chrómvanádiová oceľ, kalené magnetické hroty, ergonomická protisklzová rukoväť, vrátane držiaka, obsahuje aj hodinárske skrutkovače
BAL: 10

1533401828



sada
18 ks

INDUSTRIAL
VYVINUTÉ PRE VÄČŠIU ZÁŤAŽ



8 ks skrutkovačov:

- 1ks SL5.5*5*75
- 1ks SL6.5*6*100
- 1ks SL8.0*8*150
- 1ks SL6.5*6*38
- 1ks PH1*5*75
- 1ks PH2*6*100
- 1ks PH3*8*150
- 1ks PH2*6*38

10 ks hodinárskych skrutkovačov:

- SL1.5*50
- SL2*50
- SL2.5*50
- SL3*50
- PH00*50
- PH00*50
- PH0*50
- T6*50
- T8*50
- T10*50

Sada jemných skrutkovačov

7-dielna sada z chrómvanádiovej ocele, ergonomická rukoväť s protisklzovými vlastnosťami INGCO dizajn, plastový box, veľkosti skrutkovačov: SL2.0*50, SL2.5*50, SL3.0*50, PH00*50, PH0*50, T6*50, T8*50
BAL: 120

1533400718



sada
7 ks



Sada elektro skrutkovačov

6-dielna sada, chrómvanádiová oceľ, kalené magnetické hroty, ergonomická protisklzová rukoväť, SL3.0×75, SL4.0×100, SL6.5×150, PH0×60, PH1×80, PH2×100

BAL: 24

1533400608



sada
6 ks



Sada elektro skrutkovačov

sada 10 ks skrutkovačov plochých, krížových, elektro, testovacie pero 100–500 V, z chrómvanádiovej ocele, ergonomická rukoväť, balené v ochrannom plastovom kufríku

BAL: 10

1533400101



sada
10 ks



Sada imbusov s T-rúčkou

chrómvanádiová oceľ, sada obsahuje 8 kusov kľúčov s rúčkou v tvare T, rozmery 2-10 mm

BAL: 20

1536208081



sada
8 ks

INDUSTRIAL
VYVINUTÉ PRE VÄČŠIU ZÁŤAŽ



Sada kľúčov torx s T-rúčkou

sada 8 ks, s rúčkou v tvare T, vyrobené z vysokokvalitnej CR-V ocele, veľkosť T10x75, T15x75, T20x100, T25x100, T30x150, T40x150, T45x200, T50x200

BAL: 10

1536208083



sada
8 ks

NOVINKA



Sada očkoplochých kľúčov

sada očkoplochých kľúčov, celkom 8 ks,
veľkosť od 6 do 19 mm, 6mm, 8 mm, 10mm,
12 mm, 14 mm, 15 mm, 17 mm, 19 mm
BAL: 48
1536001088

sada
8 ks



Sada skrutkovacia T-rúčka s račňou

chrómvanádiová oceľ, T-rúčka, račňa, sada 24 kusov
BAL: 36
1533400188

sada
24 ks



Sada imbusových kľúčov

chrómvanádiová oceľ, 9 kusov
kľúčov 1,5-10 mm, tvar písmena L
BAL: 48
1536211091

sada
9 ks



Sada torxových kľúčov

chrómvanádiová oceľ, tvar písmena L,
sada 9 ks, T10 až T50
BAL: 48
1536213091

sada
9 ks



Sada imbusových kľúčov

sada 9 ks imbusových kľúčov v tvare L,
vyrobené z vysokokvalitnej CR-V ocele,
veľkosť 1,5-10 mm, predĺžené
BAL: 48
1536211092

sada
9 ks



Sada torxových kľúčov

chrómvanádiová oceľ, sada 9 kusov,
T10 až T50, predĺžené, tvar písmena L
BAL: 48
1536213092

sada
9 ks



LÁMACIE NOŽE

Lámací nôž

s tlačítkom, výška čepele 18 mm,
3x SK5 čepele v balení
BAL: 96
1535316538

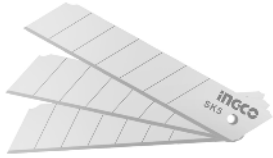

3 ČEPELE V BALENÍ



Lámací nôž

nôž zalamovací s koliečkom,
hrúbka čepele 18 mm,
vrátane 1x čepele SK5
BAL: 96
1535316618



Lámací nôž

s tlačítkom, dĺžka 100 mm,
18 mm, automatické uzamykanie
BAL: 96
1535316518



Náhradná čepeľ

náhradná čepeľ pre lámacie nože šírka 18 mm,
dĺžka 100 mm, balené v krabičke 10 ks
BAL: 30
1535300181



NOVINKA



Lámací nôž

s tlačítkom, výška
čepele 18 mm, hliníkové
telo noža zvládne
vysoké zaťaženie,
zamykanie čepele,
6x SK5 čepele v balení
BAL: 48
1535301808



6 ČEPELÍ V BALENÍ

INDUSTRIAL
VYVINUTÉ PRE VÄČŠIU ZÁŤAŽ



Pracovný nôž

univerzálny, motýliková
vymeniteľná čepeľ
vysoká 19 mm,
ergonomický úchop,
6x SK5 čepele v balení
BAL: 72
1535306128

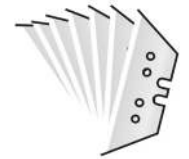

6 ČEPELÍ V BALENÍ

INDUSTRIAL
VYVINUTÉ PRE VÄČŠIU ZÁŤAŽ

Lámací nôž

s tlačítkom, hrúbka čepele
18x100 mm, vrátane
1x čepele SK5, telo noža
so zinkovej zliatiny, vhodný
pre vysokú záťaž, so zamykaním
čepele AUTO LOCK
BAL: 12
1535301807



NOVINKA

Lámací nôž

s tlačítkom, dĺžka 150 mm, 9 mm,
automatické uzamykanie
BAL: 144
1535318068



PRÁCA V DIELNI

Zverák

kovový, upínanie na stôl, s otočnou základňou,
šírka čelustí 150 mm, váha 11,2 kg
BAL: 1
1535000086

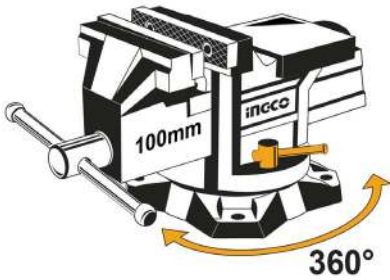
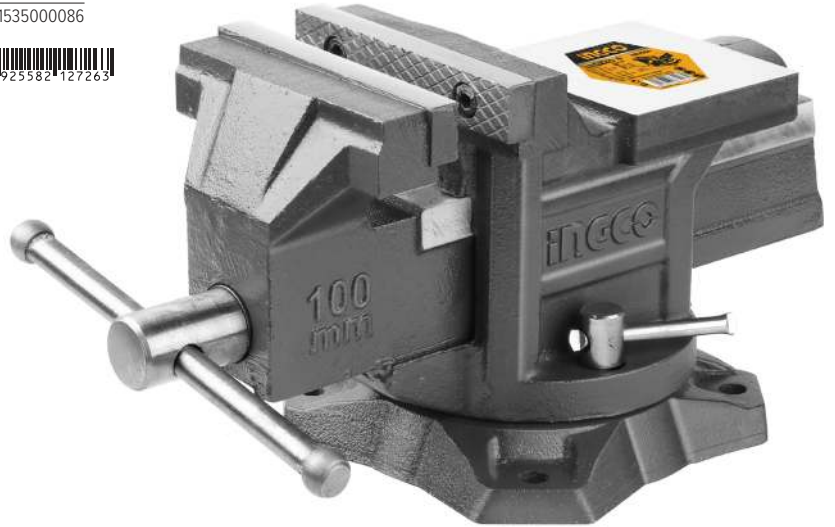

NASTAVITELNÝ ODOLNÝ HEAVY DUTY RÁM

Pílka na kov INDUSTRIAL
dĺžka 300 mm, nastaviteľný odolný
HEAVY DUTY rám s rúčkou SOFTGRIP
pre komfortné uchytenie,
systém rýchlej výmeny plátky
BAL: 24
1535203088



RÚČKA SOFTGRIP
PRE KOMFORTNÉ UCHYTENIE

SYSTÉM RÝCHLEJ VÝMENY PLÁTKU

INDUSTRIAL
VYVINUTÉ PRE VÄČŠIU ZÁŤAŽ

Pílka na kov
nastaviteľný rám s rúčkou
SOFTGRIP pre komfortné
uchytenie, dĺžka 300 mm
BAL: 24
1535203028

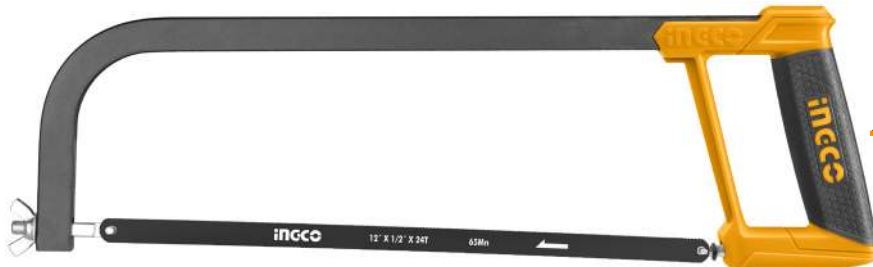

RÚČKA SOFTGRIP
PRE KOMFORTNÉ UCHYTENIE

Zošívačka - sponkovačka
kovová zošívačka 3v1, na klasické
sponky 4-14 mm, na U-spony 10-12 mm,
a na kĺnce 4-14 mm,
BAL: 1
1531901405



Zošívačka - sponkovačka
vysoko odolná kovová zošívačka na klasické sponky
4-14 mm, vhodná hrúbka spony 1,2 mm, balené v blistri
BAL: 5
1531901404



2 v 1



NOVINKA

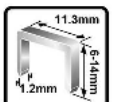
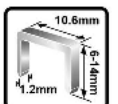

Zviňovací meter SELFLOCK

so samozastavením SELFLOCK, dvojité zviňovacie tlačidlo, gumový kryt pre lepší úchop



1537008031 3x16 mm BAL: 60
1530208008 5x19 mm BAL: 12
1530210008 5x25 mm BAL: 12



Metric



Nožnice technické

univerzálne nožnice na strihanie rôznych materiálov: papier, koža, textil, plast, guma, kartón, káble, majú ergonomickú rukoväť INCCO, čepeľ z ušľachtilej nerezovej ocele, dĺžka 20 cm

BAL: 1

1533500188



Organizér stohovateľný

plastový organizér na klince, skrutky a iné drobné súčiastky a náradie v dizajne INCCO, rozmer 340x250x60 mm, vo vnútri má priehradky, zatváranie na klip, stohovateľný s rovnakým typom organizéra

BAL: 5

1534000001



NOVINKA



STACKABLE BOX



Pistoľ vzduchová

ofukovacia pistoľ INCCO, na štandardnú EU koncovku, dĺžka nátrubku 16 mm

BAL: 25

1537400031



NOVINKA

Nožnice na plech

kovové, vysokokvalitné čeľuste, max. hrúbka strihaného plechu: uhlíková oceľ do 1,2 mm, nerezová oceľ do 0,7 mm, tvarovaná ergonomická dvojfarebná rukoväť INCCO

BAL: 5



1533501110 ľavé



1533503110 pravé

NOVINKA

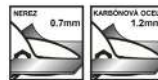

Nožnice na plech

rovné, vysokokvalitné čeľuste, max. hrúbka strihaného plechu: uhlíková oceľ do 1,2 mm, nerezová oceľ do 0,7 mm, tvarovaná ergonomická dvojfarebná rukoväť INCCO

BAL: 5

1533502110



NOVINKA

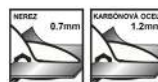

Páska sťahovacia

plastová sťahovacia páska, v balení 100 ks, farba biela

BAL: 1



1537302001 200 mm

1537303002 300 mm

1537304001 400 mm



POMÔCKY NA STAVBU

Kladivo

uhlíková ocel, pogumovaná rukoväť zo sklolaminátu

1530880100	100 g	BAL: 48
1530880200	200 g	BAL: 48
1530880300	300 g	BAL: 36
1530880500	500 g	BAL: 24
1530881000	1000 g	BAL: 12
1530881500	1500 g	BAL: 12
1530882000	2000 g	BAL: 12

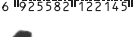
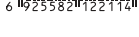

Kladivo

kovové kladivo z uhlíkovej ocele, drevená rúčka z tvrdého dreva
BAL: 6



1530740300 300 g

1530740500 500 g



NOVINKA

Kladivo - pucka

uhlíková ocel, pogumovaná sklolaminátová rúčka
BAL: 4



1530903498 4 kg

1530903598 5 kg



Tesárske kladivo

kovové tesárske kladivo z uhlíkovej ocele, 600 g, pogumovaná rukoväť, sklolaminátová ergonomická rúčka INGCO
BAL: 6
1530160028



NOVINKA





Gumové kladivo

čierne, pogumovaná rukoväť,
sklolaminátová rúčka



1530008208 220 g BAL: 40
1530008216 450 g BAL: 24



Gumové kladivo

biele, pogumovaná rukoväť,
sklolaminátová rúčka



1530008308 220 g BAL: 40
1530008316 450 g BAL: 24

Sekera

hlavica z uhlíkovej ocele s tepelne upravenou čepeľou,
pogumovaná rukoväť, sklolaminátová rúčka
BAL: 12



1530206008 600 g BAL: 12
1530208008 800 g BAL: 12
1530210008 1000 g BAL: 12
1530212508 1250 g BAL: 8



Sekera štiepacia

kovová štiepacia sekera 1000 g z uhlíkovej ocele
s tepelne upravenou čepeľou, pogumovaná
rukoväť, sklolaminátová rúčka
BAL: 6

1530310008



NOVINKA

Špicatý sekáč

celková dĺžka 300 mm, šírka 18 mm, bezpečnostná
ergonomická rúčka INGC0 pre lepšie uchopenie,
tepelne kalená uhlíková oceľ 45
BAL: 6

1535081218



NOVINKA



Vyťahovač klincov

páčidlo, pajser, oválna rúčka
BAL: 6



1535101142 35 cm
1535101242 60 cm
1535101362 90 cm
1535101482 120 cm

Sekáč plochý

celková dĺžka 300 mm, šírka 18 mm,
šírka čepele 25 mm, bezpečnostná ergonomická
rúčka INGC0 pre lepšie uchopenie
BAL: 1

1535082412



Stierka špachtľa

nerozová stierka, s ergonomicky tvarovanou rúčkou INGCO, je vhodná na rozotieranie sádry a iných tmeliacích hmôt alebo ich odstraňovaníu, prípadne odstraňovanie starých náterov a hmôt



- 1539008040 40 mm BAL: 120
- 1539008060 60 mm BAL: 48
- 1539008080 80 mm BAL: 48
- 1539008100 100 mm BAL: 48



Vymazávačka

nerozová vymazávačka 150 mm, s ergonomicky tvarovanou dvojfarebnou rúčkou INGCO
BAL: 10
1539000618



NOVINKA



Murárske hladítko

murárske hladítko, s hliníkovou INGCO rukoväťou, rozmer 280x130 mm
BAL: 48
1539028138



Murárske hladítko

murárske hladítko so zubom 10 mm, s hliníkovou INGCO rukoväťou, rozmer 280x130 mm
BAL: 10
1539128138



NOVINKA



Lis na tmel ALU

kvalitný oceľový vytlačací mechanizmus, uzavreté hliníkové telo, priemer 51 mm, vhodný na tmel v plastových vreckách (typ saláma), taktiež vhodný na použitie s bežnými kartušovými tmelmi, obsahuje 1 ks plastový adaptér/špic
BAL: 1



- 1535900109 235 mm
- 1535900112 305 mm



Lis na tmel

kovový, celková dĺžka 235 mm, s funkciou rotácie držiaka kartuše, hrúbka 1,8 mm, priemer 55 mm
BAL: 12
1535901709



NOVINKA



Vodováha

dĺžka 400 mm, 2 libely, hliníkový profil o hrúbke 1 mm, tvarované koncovky pre tlmenie nárazov, možnosť zavesiť na hák, vysoká presnosť
BAL: 40
1537228040

NOVINKA



Taška na náradie

na ukladanie ručného náradia, pevný rám pre jednoduché otváranie, vrecká dnu aj vonku, celková dĺžka 40 cm
BAL: 20
1535028161

16"



Sada vrtákov

sada 16 dielna, 6 ks vrtákov do kovu: 2, 3, 4, 5, 6, 8 mm, 5 ks vrtákov do betónu: 4, 5, 6, 8, 10 mm, 5 ks vrtákov do dreva: 4, 5, 6, 8, 10 mm
BAL: 6
1534511601

NOVINKA



Sada bit + vrtáky

45 dielna sada bitov a vrtákov do uťahovačiek, 8 ks 50 mm úderových bitov PH1/PH2/PZ1/PZ2/SL4/SL5/T23/T30, 23 ks 25 mm úderových itov PH1/ PH2/ PH3/ PZ1/ PZ2/ PZ3/ SL3/SL4/SL5/SL6/H3/H4/H5/H6/ S1/S2/S3/T10/T15/T20/T25/T30/T40, 1 ks adaptér
BAL: 6
1534524502

NOVINKA



Vrták do kovu HSS

sada 15 dielna, 1-12 mm INCCO
BAL: 12
1534551501



Sada vrtákov COMBI

11 dielna sada vrtákov do betónu 6 ks vrtákov: 3, 4, 5, 6, 8, 10 mm, 5 ks vrtákov SDS ius: 5x160 mm, 6x160 mm, 8x160 mm, 10x160 mm, 12x160 mm
BAL: 6
1534531101

NOVINKA



Sada vrtákov

sada 12 dielov, do kovu, v plastovom boxe, priemer 2, 2.5, 3, 3.5, 4, 4.5, 5, 5.5, 6, 6.5, 7, 8 mm
BAL: 20
1534501125

NOVINKA



Kotúč rezný

kotúč rezný na kov INCCO, priemer 125 mm, hrúbka 1,2 mm, otvor 22,2 mm, vhodný na oceľ a nerez



1534121151 115 mm, hrúbka 1,2 mm BAL: 100
1534121251 125 mm, hrúbka 1,2 mm BAL: 400
1534132303 230 mm, hrúbka 1,9 mm BAL: 50



MAĽOVANIE

Sada maliarska

8 dielna sada maliarských valčiekov, obsahuje:

- 1x valček 230 mm 7 mm vlas,
- 3x valček 230 mm 12 mm vlas,
- 1x valček 230 mm 18 mm vlas,
- 1x násadu INGCO s ergonomickou rukoväťou, 1x 25 mm štetec,
- 1x nádoba na farbu

BAL: 10

1535730083



NOVINKA

Valček maliarsky

náhradný maliarsky valček, rozmer 230 mm



1535723014 vlas 12 mm BAL: 1

1535752307 vlas 7 mm BAL: 50



NOVINKA

Valček maliarsky

so stredným vlasom z mikrovlákna, vhodný na hladšie povrchy, celková šírka 100 mm, výška vlasu 12 mm, vhodné do interiérov, priemer násady 6 mm, ergonomická rukoväť

BAL: 50

1535761001



NOVINKA

Štetec plochý

s drevenou rúčkou
BAL: 12

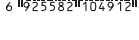

1535800110 1", 44x12 mm

1535800115 1,5", 44x13 mm

1535800120 2", 51x14 mm

1535800125 2,5", 51x16 mm

1535800130 3", 57x16 mm

1535800140 4", 57 x17,5 mm



Valček maliarsky

celková šírka 230 mm, priemer násady 6 mm, ergonomická rukoväť, na drsné povrchy (vlas 12 mm)

BAL: 40

1535742301



Valček maliarsky

celková šírka 230 mm, priemer násady 6 mm, ergonomická rukoväť na hladké povrchy (vlas 7 mm)

BAL: 40

1537572301

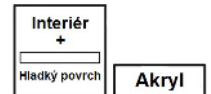
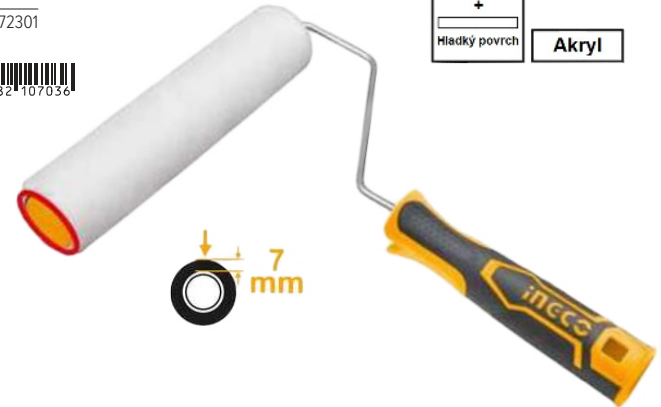

Náhradný maliarsky valček

mikrovlákno, šírka 100 mm, výška vlasu 12 mm, vhodný pre 1535761001

BAL: 45

1535761012



NOVINKA

Štetec plochý

s plastovou ergonomickou rúčkou, vysokokvalitné štetiny, vhodné aj na olejové farby



1535808615 1,5", 38 mm BAL: 240

1535808620 2", 50 mm BAL: 12

1535808625 2,5", 63 mm BAL: 12

1535808630 3", 75 mm BAL: 12

1535808640 4", 100 mm BAL: 120



NOVINKA

STAROSTLIVOSŤ O ZÁHRADU

Nožnice záhradné s pílkou

záhradné nožnice na konáre do priemeru 25 mm, s pílkou na konáre kvality SK5 s trojitými zubmi, celková dĺžka 280 cm, teleskopická rúčka dĺžky 240 cm
BAL: 8

1538025281



Záhradné nožnice

na konáre, celková dĺžka 220 mm, tepelne ošetrené vysokokvalitné čeluste z uhlíkovej ocele trieda 55, ergonomický tvar rúčok s mäkkým uchytением z materiálu TPR, strihanie do priemeru 16 mm
BAL: 12

1538000601



NOVINKA



Záhradné nožnice

na konáre, celková dĺžka 205 mm, vysokokvalitné oceľové čeluste, hliníkové rúčky s mäkkým ergonomickým uchytением z materiálu TPR

BAL: 48

1538000308



VYSOKOKVALITNÉ
OCEĽOVÉ ČELUSTE



INDUSTRIAL

VYVINUTÉ PRE VÄČŠIU ZÁŤAŽ



MAX: \varnothing 25mm



SK5 1.2MM

Nožnice na živý plot

čepel z uhlíkovej ocele,
s teflóňovou povrchovou úpravou,
ergonomické rúčky, dĺžka 56 cm
BAL: 12

1538006301



Záhradné nožnice

na konáre, celková dĺžka 760 mm, tepelne
ošetrené vysokokvalitné čeluste s povrchovou
úpravou teflóňom, ergonomicky tvar rúčok

BAL: 6

1538007401



MAXφ28mm

Nožnice na živý plot

záhradné nožnice na konáre teleskopické,
celková dĺžka 710-860 mm, tepelne
ošetrené vysokokvalitné čeluste
s povrchovou úpravou teflóňom,
ergonomický tvar rúčok

BAL: 6

1538006306



NOVINKA

PRÁCA S DREVOM

Pílka na drevo

čapovacia píla s ergonomickou rukoväťou INGCO,
dĺžka 300 mm, hustota 11 zubov na palec, s ochranou zubov

BAL: 6

1535213008



NOVINKA



Pílka na drevo

zlodejka, vysoká kvalita ocele, precízne brúsené zuby, dlhá
životnosť, dĺžka 300 mm, 7 zubov na palec, ergonomická rukoväť

BAL: 48

1535203008

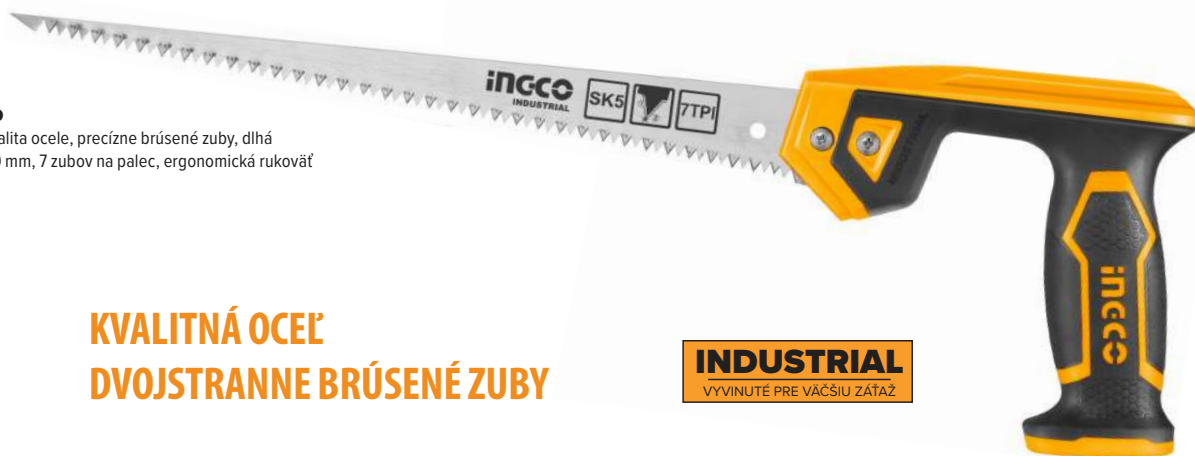

**KVALITNÁ OCEĽ
DVOJSTRANNE BRÚSENÉ ZUBY**

INDUSTRIAL
VYVINUTÉ PRE VÄČŠIU ZÁŤAŽ

Pílka na drevo

stolárska chvostová píla, 7 zubov na palec, vhodná
na rezanie dreva a plastu, hrúbka čepele 0,9 mm,
ergonomická rukoväť

BAL: 24



1535208400 400 mm



1535208500 500 mm

ERGONOMICKÁ RUKOVÄŤ



HRÚBK A ČEPELE 0,9 MM

**KVALITNÁ OCEĽ
RÝCHLY REZ
TROJSTRANNE BRÚSENÉ ZUBY**



Pílka na sadrokartón
vysokokvalitná oceľ, 8 zubov na palec,
tepelne ošetrené zuby, dĺžka 150 mm,
ergonomická rukoväť
BAL: 60
1535200068



INDUSTRIAL
VYVINUTÉ PRE VÄČŠIU ZÁŤAŽ

Pílka na drevo
prerezávacia, čepeľ z vysokokvalitnej ocele, trojstranne brúsené
zuby, 7 zubov na palec, dĺžka 300 mm, ergonomická rukoväť
BAL: 60
1538203008



INDUSTRIAL
VYVINUTÉ PRE VÄČŠIU ZÁŤAŽ



**KVALITNÁ OCEĽ
RÝCHLY REZ
DLHÁ ŽIVOTNOSŤ
TROJSTRANNE BRÚSENÉ ZUBY
7 ZUBOV NA PALEC**

Pílka na drevo
prerezávacia pílka na drevo so zatváraním čepele, veľkosť 180 mm, čepeľ vyrobená z vysokokvalitnej
taiwanskej ocele SK5, hustota 7 zubov na palec, tepelne ošetrená čepeľ, trojstranne zabrúsené zuby,
s funkciou ochrany ruky, dlhá výdrž a rýchly rez čepele
BAL: 6
1538201808



NOVINKA



Stolárska svorka

rýchlopínacia, v dizajne INCCO,
maximálna prítlačná sila 60 kg
BAL: 12



1535001601 63x150 mm
1535001602 63x300 mm
1535001603 63x450 mm



NOVINKA



INDUSTRIAL
VYVINUTÉ PRE VÄČŠIU ZÁŤAŽ

Stolárska svorka

oceľová vodiaca lišta, profilované liatinové ramená
s úpravou zabraňujúcou korózii, plastové koncovky,
ergonomická rukoväť z TPR



1535020501 50x150 mm BAL: 50
1535020502 50x200 mm BAL: 10
1535020503 50x250 mm BAL: 10
1535020802 80x300 mm BAL: 20
1535021202 120x500 mm BAL: 6
1535021203 120x800 mm BAL: 6
1535021404 140x1000 mm BAL: 6
1535021401 140x1200 mm BAL: 6

PROFILOVANÉ LIATINOVÉ RAMENÁ
S ÚPRAVOU ZABRAŇUJÚCOU KORÓZII

OCEĽOVÁ VODIACA LIŠŤA

Sada pilníkov

ergonomická rukoväť, celková
dĺžka 200 mm, plochy/ okrúhly/
polokrúhly/trojuholník/štvorec
BAL: 10

1535400508



INDUSTRIAL
VYVINUTÉ PRE VÄČŠIU ZÁŤAŽ



Sada dlát

chrómvanádiová oceľ, šírka 6/12/19/25 mm,
dĺžka 140 mm, ergonomická rúčka
z TPR pre lepšie uchopenie
BAL: 16

1535100401

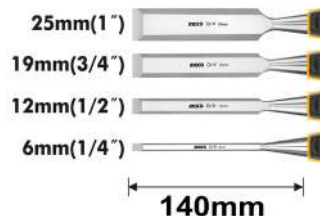

INGCO

NÁRADIE DO TVOJICH RÚK

Skús

KINEKUS

EXKLUZÍVNY DODÁVATEĽ



**V KATALÓGU NÁJDETE
AJ NOVINKY 2022**

BRATISLAVA - VAJNORY

NC Vajnoria, Pri starom letisku 3, 0945 800 322

BRATISLAVA - PETRŽALKA

Fedinova 14, 02/638 11 447, 0918 378 463

NITRA

HomeBox oproti MÖBELIXU, Bratislavská 35, 0902 900 596

TRENČÍN

Belá 7575 (oproti OC Laugaricio), 032/640 12 95 - 96

RUŽOMBEROK

Bystrická cesta 2159, 044/435 39 10 - 12

PÚCHOV

Okružná 1746/74 (pri ČS Slovnaft) 042/471 03 03 - 5

PRIEVIDZA

Nábrežná 11, 0907 999 225

ŽILINA

Kamená 4, 041/777 77 77

MARTIN

Pri TESCO, OC TURIEC, 0907 999 223

ŠUMPERK

Žerotínova 2833/46

PREŠOV

vynovená predajňa

Vihorlatská 1/A (budova Hypernovy), 051/242 00 20

POP RAD

Dlhé Hony 5268/9 (OC Kriváň oproti OC MAX), 052/202 22 02

KOŠICE

nová adresa

OC Cassovia, Pri Prachárni 4, 055/789 84 62

a v ďalších 150 partnerských obchodoch...

www.kinekus.sk/partnerskeobchody

e-shop

www.kinekus.sk